

C4D40120D–Silicon Carbide Schottky Diode

Z-REC™ RECTIFIER

V_{RRM}	= 1200 V
$I_{F(AVG)}$ Both Legs	= 40 A
Q_c	= 130 nC

Features

- 1.2kV Schottky Rectifier
- Zero Reverse Recovery Current
- High-Frequency Operation
- Temperature-Independent Switching
- Extremely Fast Switching

Benefits

- Replace Bipolar with Unipolar Rectifiers
- Essentially No Switching Losses
- Higher Efficiency
- Reduction of Heat Sink Requirements
- Parallel Devices Without Thermal Runaway

Applications

- Switch Mode Power Supplies
- Power Factor Correction
- Motor Drives

Package

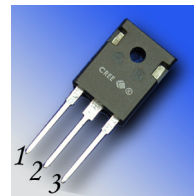

TO-247-3

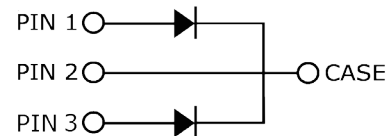

Part Number	Package	Marking
C4D40120D	TO-247-3	C4D40120

Maximum Ratings ($T_c=25^\circ\text{C}$ unless otherwise specified)

Symbol	Parameter	Value	Unit	Test Conditions	Note
V_{RRM}	Repetitive Peak Reverse Voltage	1200	V		
V_{RSM}	Surge Peak Reverse Voltage	1300	V		
V_R	DC Peak Reverse Voltage	1200	V		
$I_{F(AVG)}$	Maximum DC Current (Per Leg/Device)	27/54	A	$T_c=135^\circ\text{C}$, no AC component	
I_{FRM}	Repetitive Peak Forward Surge Current	91* 61*	A	$T_c=25^\circ\text{C}$, $t_p=10$ ms, Half Sine Pulse $T_c=110^\circ\text{C}$, $t_p=10$ ms, Half Sine Pulse	
I_{FSM}	Non-Repetitive Forward Surge Current	130* 110*	A	$T_c=25^\circ\text{C}$, $t_p=10$ ms, Half Sine Pulse $T_c=110^\circ\text{C}$, $t_p=10$ ms, Half Sine Pulse	
I_{FSM}	Non-Repetitive Forward Surge Current	TBD	A	$T_c=25^\circ\text{C}$, $t_p=10$ μs , rectangular Pulse	
P_{tot}	Power Dissipation (Per Leg/Device)	242/484 104/208	W	$T_c=25^\circ\text{C}$ $T_c=110^\circ\text{C}$	
T_j	Operating Junction Range	-55 to +175	$^\circ\text{C}$		
T_{stg}	Storage Temperature Range	-55 to +135	$^\circ\text{C}$		
	TO-247 Mounting Torque	1 8.8	Nm lbf-in	M3 Screw 6-32 Screw	

** Per Device, * Per Leg

Electrical Characteristics (Per Leg)

Symbol	Parameter	Typ.	Max.	Unit	Test Conditions	Note
V_F	Forward Voltage	1.5 2.2	1.8 3	V	$I_F = 20\text{ A}$ $T_J = 25^\circ\text{C}$ $I_F = 20\text{ A}$ $T_J = 175^\circ\text{C}$	
I_R	Reverse Current	35 65	200 400	μA	$V_R = 1200\text{ V}$ $T_J = 25^\circ\text{C}$ $V_R = 1200\text{ V}$ $T_J = 175^\circ\text{C}$	
Q_C	Total Capacitive Charge	130		nC	$V_R = 1200\text{ V}$, $I_F = 20\text{ A}$ $di/dt = 200\text{ A}/\mu\text{s}$ $T_J = 25^\circ\text{C}$	
C	Total Capacitance	1500 93 67		pF	$V_R = 0\text{ V}$, $T_J = 25^\circ\text{C}$, $f = 1\text{ MHz}$ $V_R = 400\text{ V}$, $T_J = 25^\circ\text{C}$, $f = 1\text{ MHz}$ $V_R = 800\text{ V}$, $T_J = 25^\circ\text{C}$, $f = 1\text{ MHz}$	

Note:

1. This is a majority carrier diode, so there is no reverse recovery charge.

Thermal Characteristics

Symbol	Parameter	Typ.	Max.	Unit	Test Conditions	Note
$R_{\theta JC}$	Thermal Resistance from Junction to Case	0.31** 0.62*		$^\circ\text{C}/\text{W}$		

** Per Device, * Per Leg

Typical Performance (Per Leg)

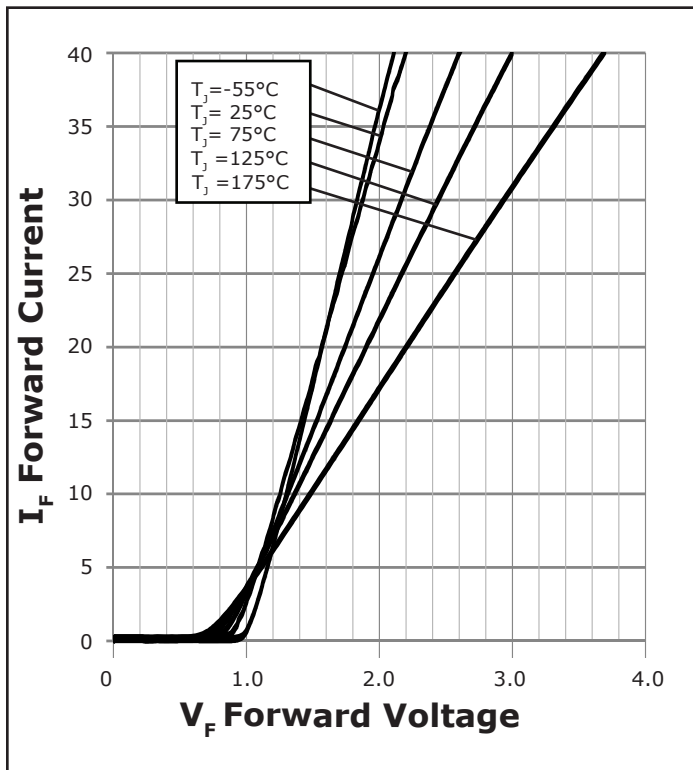

Figure 1. Forward Characteristics

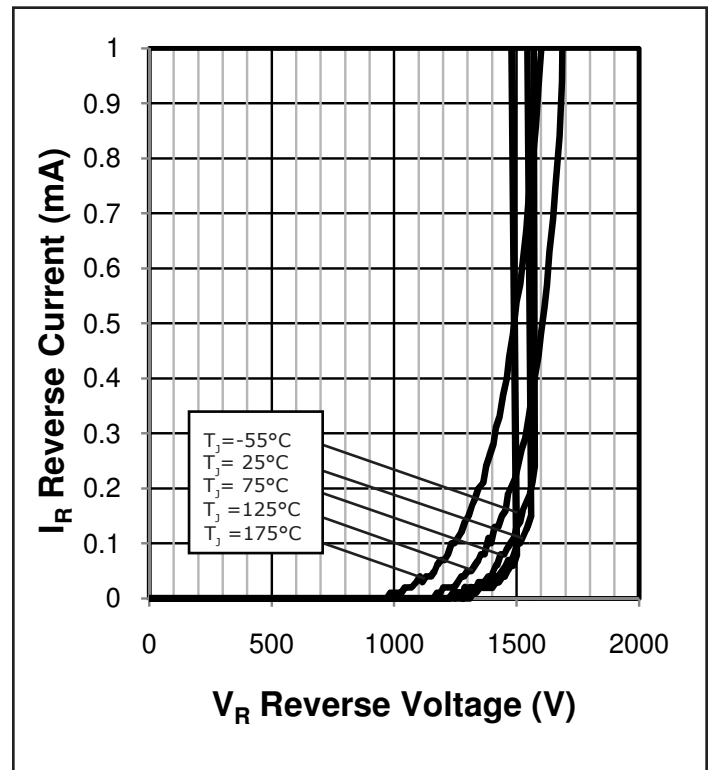

Figure 2. Reverse Characteristics

Typical Performance (Per Leg)

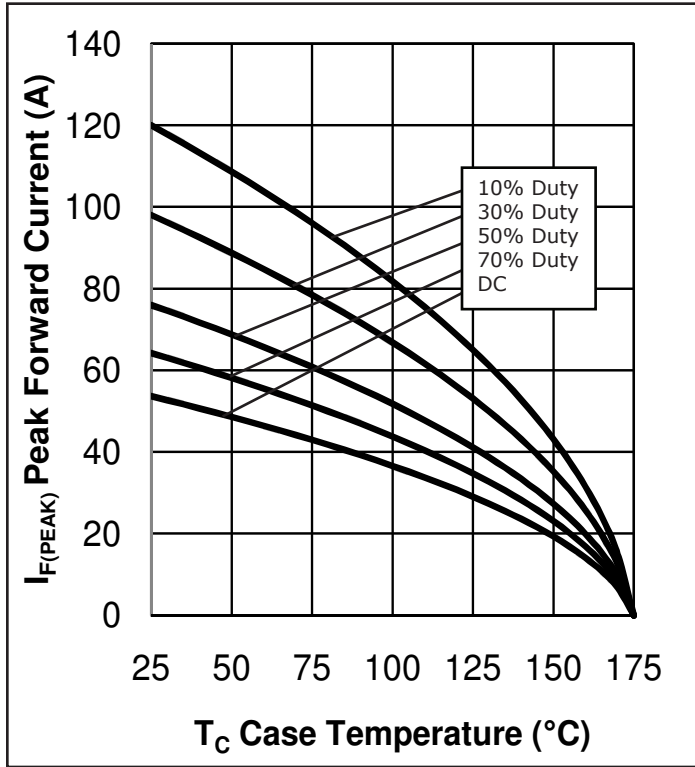

Figure 3. Current Derating

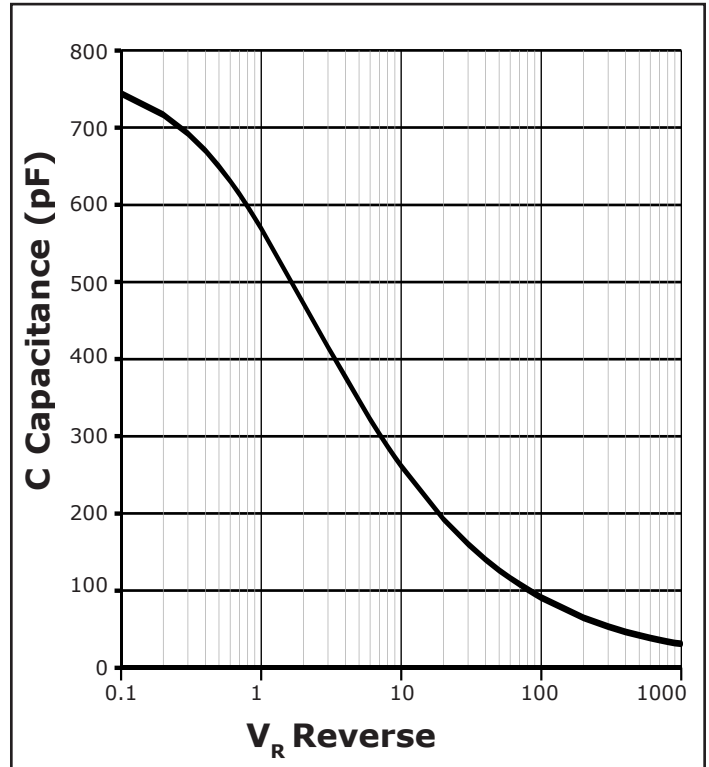

Figure 4. Capacitance vs. Reverse Voltage

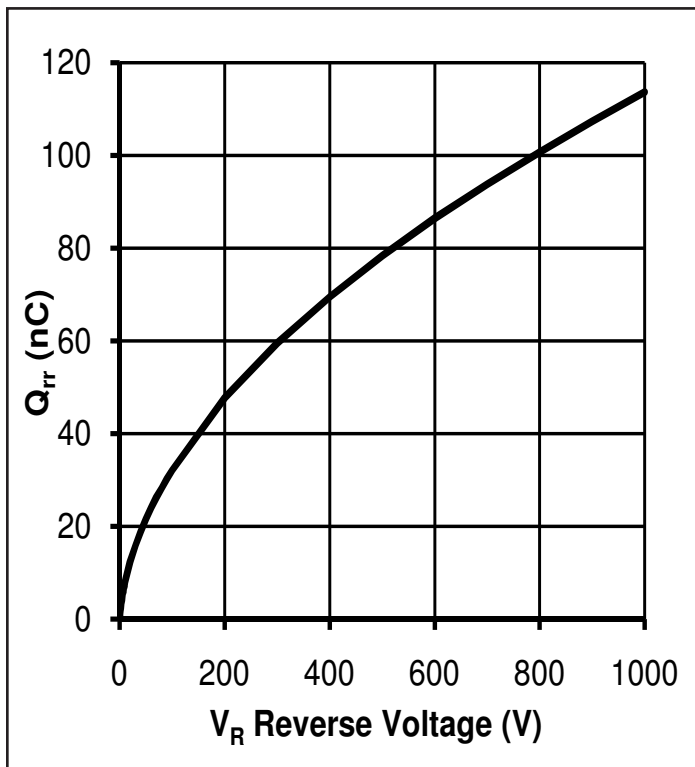

Figure 5. Recovery Charge vs. Reverse Voltage

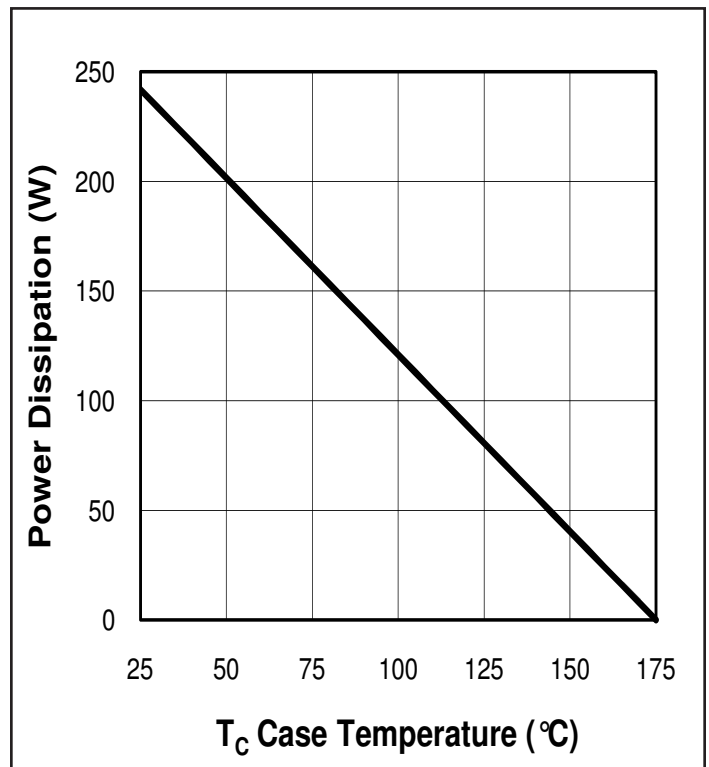

Figure 6. Power Derating

Typical Performance (Per Leg)

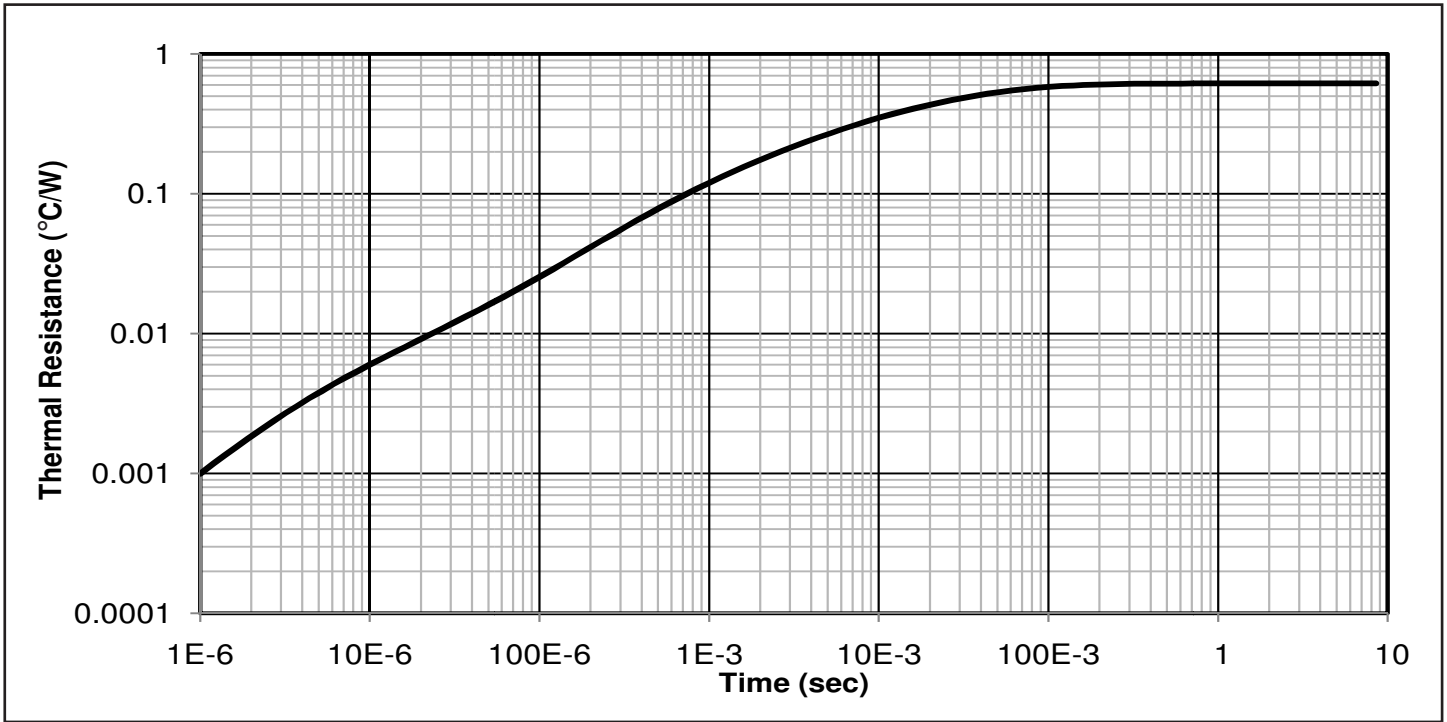
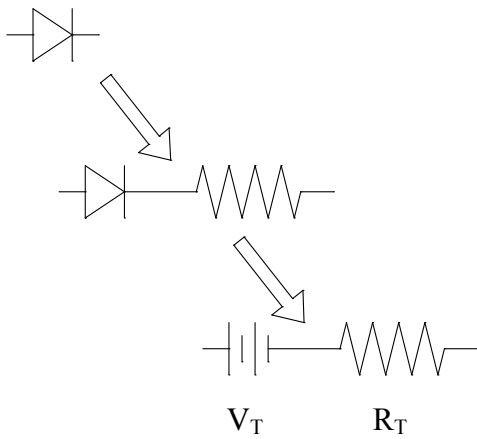

Figure 7. Transient Thermal Impedance

Diode Model



$$V_{fT} = V_T + I_f * R_T$$

$$V_T = 0.97 + (T_j * -1.40 * 10^{-3})$$

$$R_T = 0.023 + (T_j * 2.71 * 10^{-4})$$

Note: T_j = Diode Junction Temperature In Degrees Celcius



Package Dimensions

Package TO-247-3

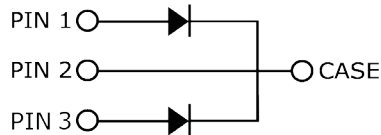
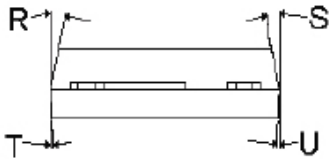
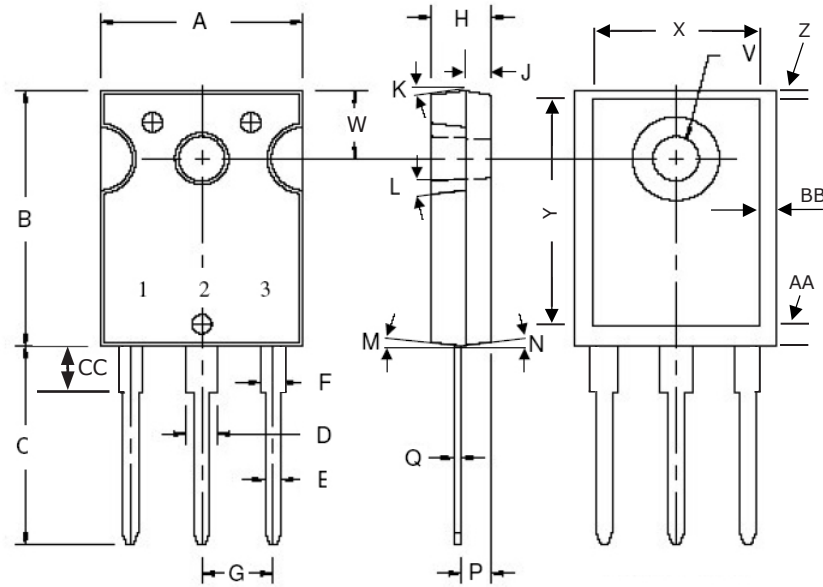

POS	Inches		Millimeters	
	Min	Max	Min	Max
A	.605	.640	15.367	16.250
B	.800	.839	20.320	21.300
C	.778	.800	19.750	20.310
D	.095	.126	2.413	3.200
E	.045	.052	1.150	1.321
F	.060	.087	1.524	2.200
G	.217 TYP		5.500 TYP	
H	.175	.203	4.450	5.156
J	.078	.081	1.982	2.057
K	6°	21°	6°	21°
L	4°	6°	4°	6°
M	2°	4°	2°	4°
N	2°	4°	2°	4°
P	.090	.097	2.286	2.464
Q	.018	.030	.450	.762
R	9°	11°	9°	11°
S	9°	11°	9°	11°
T	2°	8°	2°	8°
U	2°	8°	2°	8°
V	.126	.144	3.200	3.658
W	.210	.238	5.334	6.050
X	.502	.557	12.751	14.148
Y	.637	.695	16.180	17.653
Z	.040	.052	1.016	1.321
AA	.110	.140	2.794	3.556
BB	.032	.046	.813	1.168
CC	.146	.176	3.700	4.472

Recommended Solder Pad Layout

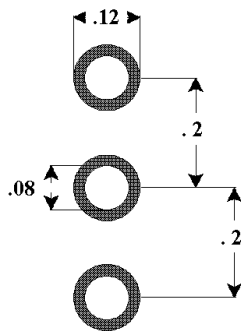

TO-247-3

Part Number	Package	Marking
C4D40120D	TO-247-3	C4D40120

"The levels of environmentally sensitive, persistent biologically toxic (PBT), persistent organic pollutants (POP), or otherwise restricted materials in this product are below the maximum concentration values (also referred to as the threshold limits) permitted for such substances, or are used in an exempted application, in accordance with EU Directive 2002/95/EC on the restriction of the use of certain hazardous substances in electrical and electronic equipment (RoHS), as amended through April 21, 2006."

This product has not been designed or tested for use in, and is not intended for use in, applications implanted into the human body nor in applications in which failure of the product could lead to death, personal injury or property damage, including but not limited to equipment used in the operation of nuclear facilities, life-support machines, cardiac defibrillators or similar emergency medical equipment, aircraft navigation or communication or control systems, air traffic control systems, or weapons systems.

Copyright © 2006-2011 Cree, Inc. All rights reserved. The information in this document is subject to change without notice. Cree, the Cree logo, and Zero Recovery are registered trademarks of Cree, Inc.

Cree, Inc.
4600 Silicon Drive
Durham, NC 27703
USA Tel: +1.919.313.5300
Fax: +1.919.313.5451
www.cree.com/power