

C3D02060E – Silicon Carbide Schottky Diode

Z-REC™ RECTIFIER

$V_{RRM} = 600\text{ V}$
 $I_{F(AVG)} = 2\text{ A}$
 $Q_c = 4.8\text{ nC}$

Features

- 600-Volt Schottky Rectifier
- Optimized for PFC Boost Diode Application
- Zero Reverse Recovery Current
- Zero Forward Recovery Voltage
- High-Frequency Operation
- Temperature-Independent Switching Behavior
- Extremely Fast Switching
- Positive Temperature Coefficient on V_F

Benefits

- Replace Bipolar with Unipolar Rectifiers
- Essentially No Switching Losses
- Higher Efficiency
- Reduction of Heat Sink Requirements
- Parallel Devices Without Thermal Runaway

Applications

- Switch Mode Power Supplies
- Power Factor Correction
- Typical PFC P_{out} : 300W-450W

Package

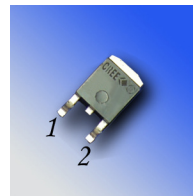

TO-252-2



Part Number	Package	Marking
C3D02060E	TO-252-2	C3D02060

Maximum Ratings

Symbol	Parameter	Value	Unit	Test Conditions	Note
V_{RRM}	Repetitive Peak Reverse Voltage	600	V		
V_{RSM}	Surge Peak Reverse Voltage	600	V		
V_{DC}	DC Blocking Voltage	600	V		
$I_{F(AVG)}$	Average Forward Current	2.0	A	$T_c = 150^\circ\text{C}$	
I_{FRM}	Repetitive Peak Forward Surge Current	12.0 9.0	A	$T_c = 25^\circ\text{C}$, $t_p = 10\text{ mS}$, Half Sine Wave $D = 0.3$ $T_c = 110^\circ\text{C}$, $t_p = 10\text{ mS}$, Half Sine Wave $D = 0.3$	
I_{FSM}	Non-Repetitive Peak Forward Surge Current	21 19	A	$T_c = 25^\circ\text{C}$, $t_p = 10\text{ mS}$, Half Sine Wave $D = 0.3$ $T_c = 110^\circ\text{C}$, $t_p = 10\text{ mS}$, Half Sine Wave $D = 0.3$	
I_{FSM}	Non-Repetitive Peak Forward Surge Current	65	A	$T_c = 25^\circ\text{C}$, $t_p = 10\text{ }\mu\text{S}$, Pulse	
P_{tot}	Power Dissipation	39.5 17	W	$T_c = 25^\circ\text{C}$ $T_c = 110^\circ\text{C}$	
T_J, T_{stg}	Operating Junction and Storage Temperature	-55 to +175	$^\circ\text{C}$		
	TO-220 Mounting Torque	1 8.8	Nm lbf-in	M3 Screw 6-32 Screw	

PRELIMINARY

Electrical Characteristics

Symbol	Parameter	Typ.	Max.	Unit	Test Conditions	Note
V_F	Forward Voltage		1.7 2.4	V	$I_F = 2\text{ A}$ $T_J = 25^\circ\text{C}$ $I_F = 2\text{ A}$ $T_J = 175^\circ\text{C}$	
I_R	Reverse Current	10 20	50 100	μA	$V_R = 600\text{ V}$ $T_J = 25^\circ\text{C}$ $V_R = 600\text{ V}$ $T_J = 175^\circ\text{C}$	
Q_C	Total Capacitive Charge	4.8		nC	$V_R = 600\text{ V}$, $I_F = 2\text{ A}$ $di/dt = 500\text{ A}/\mu\text{S}$ $T_J = 25^\circ\text{C}$	
C	Total Capacitance	120 12 11		pF	$V_R = 0\text{ V}$, $T_J = 25^\circ\text{C}$, $f = 1\text{ MHz}$ $V_R = 200\text{ V}$, $T_J = 25^\circ\text{C}$, $f = 1\text{ MHz}$ $V_R = 400\text{ V}$, $T_J = 25^\circ\text{C}$, $f = 1\text{ MHz}$	

Note:

1. This is a majority carrier diode, so there is no reverse recovery charge.

Thermal Characteristics

Symbol	Parameter	Typ.	Unit
$R_{\theta JC}$	TO-220 Package Thermal Resistance from Junction to Case	3.8	$^\circ\text{C}/\text{W}$

Typical Performance

PRELIMINARY

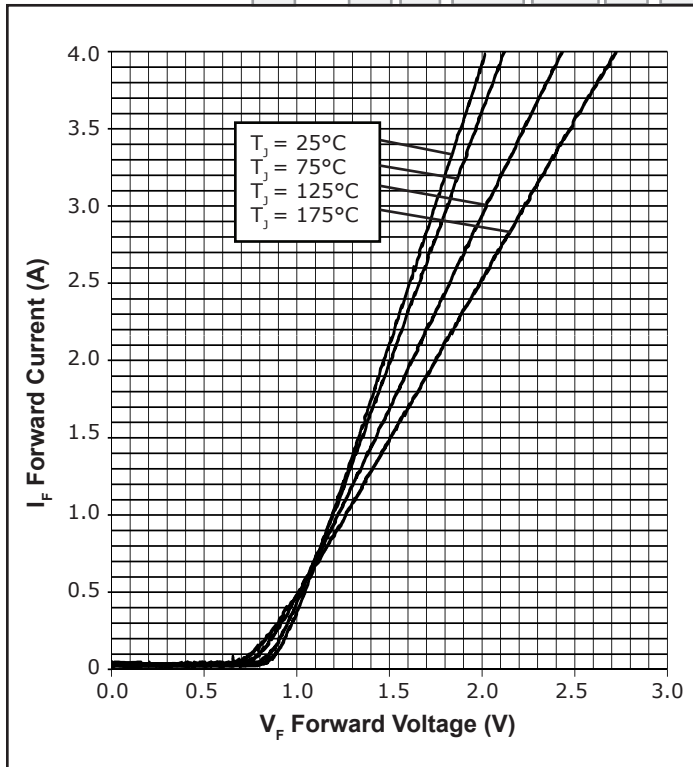

Figure 1. Forward Characteristics

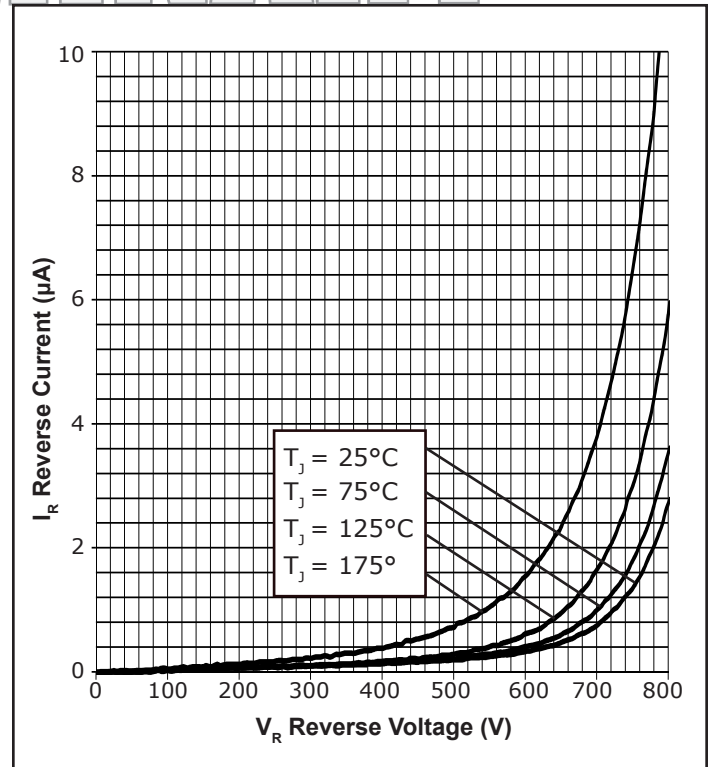

Figure 2. Reverse Characteristics

Typical Performance

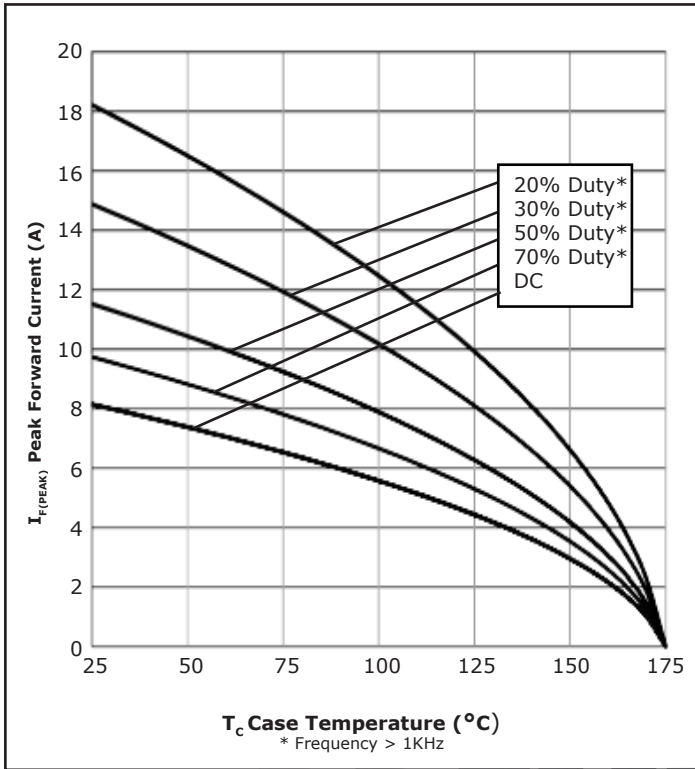

Figure 3. Current Derating

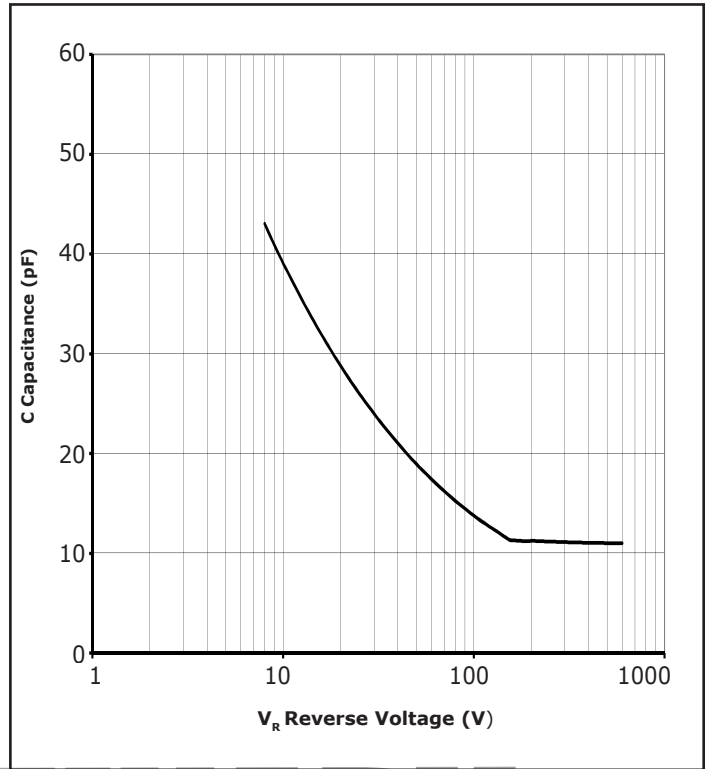

Figure 4. Capacitance vs. Reverse Voltage

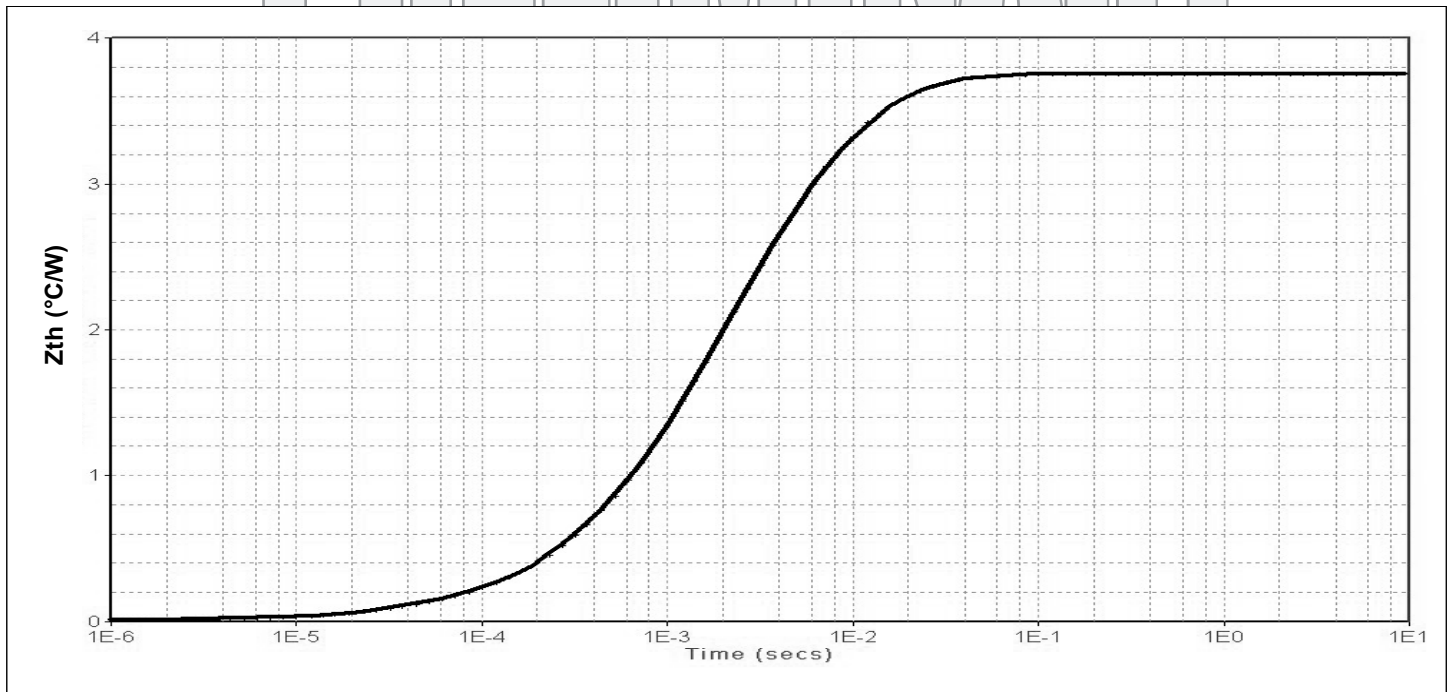

Figure 5. Transient Thermal Impedance

Typical Performance

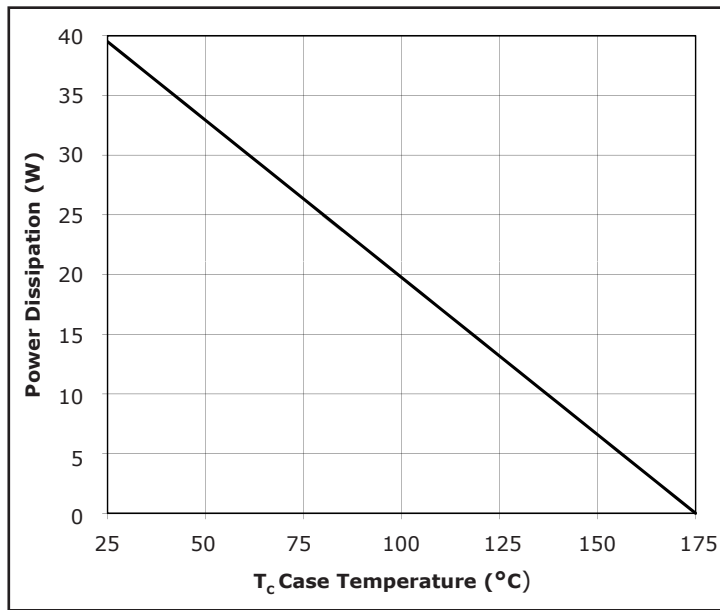
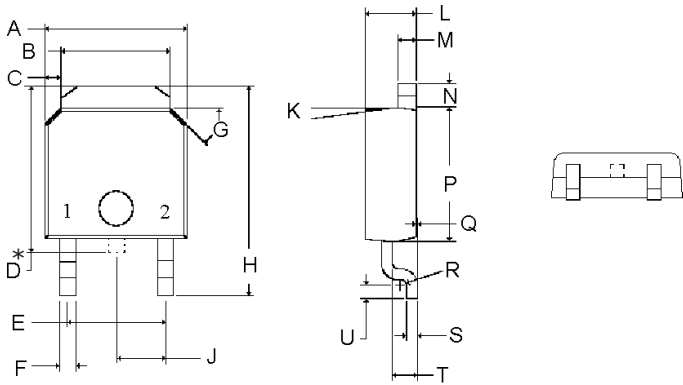

Figure 6. Power Derating

PRELIMINARY

Package Dimensions

Package TO-252-2



POS	Inches		Millimeters	
	Min	Max	Min	Max
A	.255	.265	6.477	6.731
B	.197	.205	5.004	5.207
C	.027	.033	.686	.838
D*	.270	.322	6.858	8.179
E	.178	.182	4.521	4.623
F	.025	.035	.635	.889
G	44°	46°	44°	46°
H	.382	.397	9.703	10.084
J	.090 TYP		2.286 TYP	
K	6°	8°	6°	8°
L	.086	.094	2.184	2.388
M	.030	.034	.762	.864
N	.040	.044	1.016	1.118
P	.235	.245	5.969	6.223
Q	0.00	.004	0.00	.102
R	R0.01 TYP		R0.31 TYP	
S	.017	.023	.428	.588
T	.040	.044	1.016	1.118
U	.021	.027	.534	1.118

Note:
* Tab "D" may not be present

Recommended Solder Pad Layout

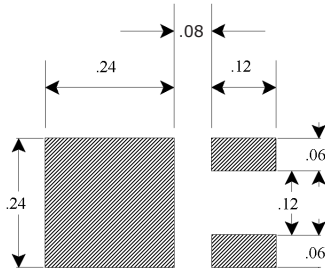

TO-252-2

Part Number	Package	Marking
C3D02060E	TO-252-2	C3D02060

Diode Model

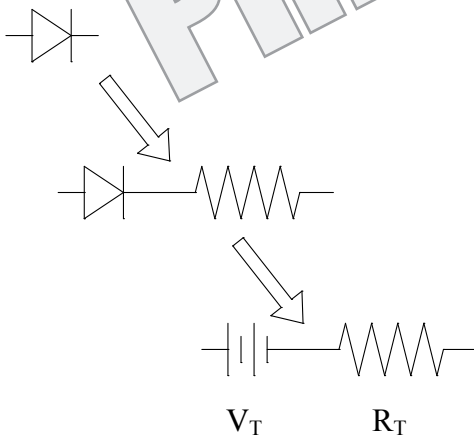

$$V_{fT} = V_T + I_f * R_T$$

$$V_T = 0.98 + (T_j * -1.7 * 10^{-3})$$

$$R_T = 0.21 + (T_j * 1.71 * 10^{-3})$$

Note: T_j = Diode Junction Temperature In Degrees Celcius

"The levels of environmentally sensitive, persistent biologically toxic (PBT), persistent organic pollutants (POP), or otherwise restricted materials in this product are below the maximum concentration values (also referred to as the threshold limits) permitted for such substances, or are used in an exempted application, in accordance with EU Directive 2002/95/EC on the restriction of the use of certain hazardous substances in electrical and electronic equipment (RoHS), as amended through April 21, 2006.

This product has not been designed or tested for use in, and is not intended for use in, applications implanted into the human body nor in applications in which failure of the product could lead to death, personal injury or property damage, including but not limited to equipment used in the operation of nuclear facilities, life-support machines, cardiac defibrillators or similar emergency medical equipment, aircraft navigation or communication or control systems, air traffic control systems, or weapons systems.

Copyright © 2009 Cree, Inc. All rights reserved. The information in this document is subject to change without notice. Cree and the Cree logo are registered trademarks and Z-Rec is a trademark of Cree, Inc.

Cree, Inc.
4600 Silicon Drive
Durham, NC 27703
USA Tel: +1.919.313.5300
Fax: +1.919.313.5451
www.cree.com/power